

EVO

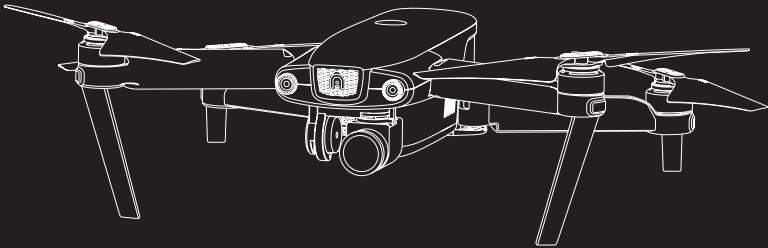

User Manual

With XI-5A Gimbal

AUTEL
ROBOTICS

Trademark Acknowledgement

EVO™, **Autel Explorer™**, **Starpoint™** and the **Autel Robotics®** logo are trademarks of Autel Robotics Co., Ltd., registered in China, the United States and other countries. All other products and company names mentioned in this User Manual are registered trademarks of their respective holders.

Copyright Warning

Reproduction or retransmission of any part of this manual in any form or by any means, whether electronic, mechanical, photocopying, recording, or otherwise, is forbidden without the express written permission of Autel Robotics.

Disclaimer

Please closely follow the steps in these instructions in order to ensure safe and successful operation of your **EVO** aircraft.

EVO should only be used by children while under close adult supervision. We strongly recommend making sure that kids can't access the aircraft when it's idle.

Autel Robotics provides no warranty coverage for product damages that occur during use if the customer fails to follow the safety instructions, and neither is it liable for any damages incurred during product use, be they direct or indirect, legal, special, incidental, or economic (including but not limited to loss of profits). Do not use incompatible components or attempt to modify **EVO** in any way inconsistent with the instructions in the official aircraft documentation.

These safety instructions will show you the steps to get started safely with **EVO**. Only you can ensure that you fly **EVO** securely and never jeopardize the safety of yourself, other people, or their property.

Our safety instructions will be updated over time. To make sure you have the latest version, visit www.autelrobotics.com/support/downloads/.

Data Storage and Usage

When the backup service is disabled, as it is by default, no flight or user data will be uploaded or transmitted via the mobile app. When the **Autel Explorer™** mobile app is paired with the aircraft, flight log data, including flight telemetry, will be uploaded and maintained on Autel Robotics data servers. All telemetry and flight logs are stored on data servers located within the boundaries of the continental United States, and the data upload occurs automatically only if the Flight Log Backup option is enabled.

The Autel customer service team doesn't have access to flight log data except

when explicitly granted permission by the user via the mobile app. When that permission is granted, only flight logs within the selected date range will be accessed.

Information, including still and motion imagery and data from the aircraft's sensors, will be stored on the **EVO's** internal drive. If your aircraft ever needs to be sent to us for service, the information on the internal storage unit may be used to diagnose problems with the aircraft. The information will not be retained except as required to process the service or repair. Do not remove or alter the data on the internal storage device in any way. Doing so will invalidate all warranty coverage.

Autel Robotics' purpose in gathering data is to provide support and service for our customers, and to improve the performance of our products. We take your privacy as seriously as we do our own. We will consent to the disclosure of uploaded data only when required by law to do so.

Safety Instructions

Battery Safety

A lithium-polymer battery powers the aircraft. The misuse of Li-Po/Li-Ion batteries can be hazardous. As such, make sure to follow all the battery usage, charging and storage instructions below.

WARNING

- The battery is factory-replaceable only. Do not tamper with either the battery pack or its charger, or replace them with third-party devices.
- Battery electrolytes are highly corrosive. If any electrolyte is splashed onto your skin or in your eyes, immediately wash the affected area with fresh running water and consult a doctor.

Battery Usage

Always remember to turn off the aircraft before installing or removing the battery. Other notes:

- Only use the battery and charger provided by Autel Robotics. An unapproved battery or charger may result in fire, explosion, leakage or other hazards. Autel Robotics takes no responsibility for any damage caused by the third party batteries or charging devices
- When not in use, remove the battery from the aircraft to prevent trickle discharge
- Keep the battery stored in a safe, dry, warm environment
- Do not disassemble, open, crush, bend, deform, puncture, or shred the battery

- Do not modify, remanufacture, or attempt to insert foreign objects into the battery
- Do not place heavy objects on the battery or charger
- Stop using or charging the battery immediately if it starts to swell, smoke or leak
- Use the battery at temperatures between -10°C and 40°C. Extremely high temperatures may cause a fire or explosive damage; extremely low temperatures may lead to permanent battery damage
- Before flying in a low-temperature environment (between -10°C and 15°C), fully charge the battery in warmer temperatures, or insert it into EVO and hover the aircraft at an altitude of 1m until the battery warms up to 15°C or higher. The battery temperature can be monitored using the mobile app
- Do not use the battery in strong electrostatic or electromagnetic environments
- Do not expose the battery to fire, explosions, or other hazards
- The heavier the aircraft loads, the shorter the flight time

If the aircraft falls into the water, remove the battery immediately after you retrieve it. Leave the battery in an open area and maintain a safe distance until it is completely dry. Don't use the battery again. Contact our customer support team for a replacement.

Battery Charging

It should take a maximum of 80 minutes to fully charge the EVO battery, though charging times will vary according to the remaining battery level. Other battery charging notes and words of caution:

- Do not use a damaged battery charger
- When the charger is not in use, we recommend disconnecting it
- Do not charge the battery immediately after flight, as overheat protection will prevent the battery from being charged before it cools completely
- Overcharging may shorten battery life, so don't leave the battery unattended during charging, and remove it after it's fully charged

We strongly recommend that you go through a charge cycle — wherein you charge the battery to 100% and then discharge it to 7% or lower — every three months, or after the battery has been used for 20 consecutive charges.

Battery Storage

In storage as in flight, it's important not to allow the battery to come in close contact with moisture or heat sources. Store the battery in a dry and ventilated area at room temperature (ideally 22°C to 28°C). Other storage notes:

- Keep the battery out of reach of children and pets

- Do not place the battery next to sharp items, or on a conductive surface (e.g., metal plate)
- Do not put the battery in the wet grass or pocket with metal objects
- Make sure the battery voltage level does not fall below 3V during storage
- Using or storing the battery in extreme environments may reduce overall battery life
- Because battery life inevitably shortens over time, the life of your battery may be reduced if it is left unused over an extended period

Battery Disposal

- Completely discharge the battery before disposal
- Dispose of the battery properly at an approved battery recycling location

Flying EVO Safely & Securely

Take-off & Landing

Place the aircraft on a level, open surface and stand at a distance of at least 5 meters to its rear. If possible, we highly recommend having an experienced pilot on hand during your first flight. Other takeoff and landing guidelines:

- Do not take off or land on slopes or uneven surfaces
- Fly in an open and safe area. Avoid buildings, trees, people, power lines, and moving vehicles
- Keep the aircraft steady once it is less than one meter off the ground during landing
- When the low battery warning sign displays, land immediately — even if the flight is finished soon
- Note that the temperature and wind conditions may affect the use of energy from the battery

Flight Requirements

Always turn on the remote control first, then the aircraft (except when pairing the remote control to the aircraft). Likewise, power off the aircraft first, then the remote control. Other flight guidelines:

- Avoid flying the aircraft at a low altitude or getting too close to people
- Keep the aircraft in your visual line of sight at all times
- Keep the aircraft away from potential obstacles (trees, buildings, etc.)
- Leave plenty of space for turning and moving

- Avoid flying in hazardous situations or severe weather conditions, including rain, storms, hail, and snow
- To avoid failure of positioning, steer clear of facilities that could produce electromagnetic interference, such as power plants, transmission lines, substations, or broadcasting towers
- Be wary of potential interference from other remote controls and interference sources
- When a warning appears on the app, follow the corresponding instructions closely
- Make sure you are not drunk, high or suffering from dizziness, fatigue or any other physical condition that may impair your ability to safely operate the aircraft

 **WARNING**

If any part of the aircraft or the remote control fails to function correctly or has visible damage, do not fly the aircraft and get in touch with our support team at www.autelrobotics.com/contact-us/.

Storage & Maintenance

Carefully check every part of the aircraft after any crash or collision. Keep the **EVO** aircraft, including camera gimbal holder and propellers, stored out of the reach of children and pets.

- Store the aircraft, battery and remote control in a cool, dry place
- Keep **EVO** away from water and heat sources
- The recommended storage temperature for the aircraft is 22°C to 28°C

Our support team stands ready to help via chat, phone or email at www.autelrobotics.com/contact-us/.

Contents

Chapter 1 About This Manual	1
1.1 Legends	1
1.2 Before First Flight	1
1.2.1 Reading the Included Documents	1
1.2.2 Mobile App Installation (Optional)	2
Chapter 2 Getting to Know Your Smart Drone	3
2.1 Aircraft	3
2.1.1 Functionality Description	3
2.1.2 Flight LED Indicators	5
2.1.3 Aircraft Battery	6
2.1.4 Gimbal & Camera	9
2.1.5 Built-in Smart Flight System	11
2.1.6 Smart Flight Features	12
2.2 Remote Control	16
2.2.1 Functionality Description	16
2.2.2 Live View Panel	18
2.2.3 Indicator Lights	22
2.2.4 Remote Controller Buzzer Alerts	23
Chapter 3 Preflight Preparation	24
3.1 Battery Preparation	24
3.1.1 Aircraft Battery Installation	24
3.1.2 Aircraft Battery Removal	24
3.1.3 Charging	24
3.2 Remote Control Preparation	26
3.2.1 Unfolding the Remote Control	26
3.2.2 Powering Up/Off the Remote Control	27
3.2.3 Remote Control Calibration	27
3.2.4 Pairing the Aircraft & Remote Control	28

3.3 Aircraft Preparation	29
3.3.1 Unfolding the Aircraft	29
3.3.2 Propellers Installation	30
3.3.3 Compass Calibration	31
Chapter 4 Flight Operations	33
4.1 Preflight Checklist	33
4.2 Remote Control & Flight Operations	33
4.2.1 Motor Start & Aircraft Takeoff	34
4.2.2 Command Stick Controls (Mode 2)	34
4.2.3 Landing & Motor Shutdown	36
Chapter 5 Maintenance & Service	39
5.1 Firmware Upgrade	39
5.2 Troubleshooting Tips	40
5.3 Storage & Maintenance	41
5.4 Warranty	41
5.5 Customer Service	42
5.5.1 Technical Support	42
5.5.2 Repair Service	42
Chapter 6 Appendix	44
6.1 Regulatory Compliance & Flight Restricted Area	44
6.1.1 Compliance & Advisory	44
6.1.2 Flight Restricted Area Illustration	45
6.2 Specifications	47





Chapter 1

About This Manual

Thank you for purchasing **EVO** and welcome to the Autel Robotics family. Use this manual to get a detailed look at **EVO**'s features and how best to make use of them when operating the aircraft and remote control. Please read it in its entirety — with the other included documentation — before flying your **EVO** for the first time, and keep it at hand for easy consultation while you get to know your aircraft.

1.1 Legends

Pay special attention to the callouts appear throughout this manual.

-  **WARNING:** Points out a potentially hazardous situation.
-  **IMPORTANT:** Something to be aware of during **EVO** flight operation.
-  **NOTE:** Supplementary information.
-  **TIPS:** How to get the most out of your **EVO** experience.
-  **REFERENCE:** A page number that guides you to the section containing relevant information in this manual.

1.2 Before First Flight

1.2.1 Reading the Included Documents

Prior to flying your **EVO** for the first time, make sure you've got all the documentation that will help you get started:

1. **EVO Packing List:** Use the **Packing List** to verify that all the items are in the box. Contact us or your local retailer if anything's missing
2. **EVO Disclaimer & Safety Instructions:** Notes on how to operate **EVO** safely and responsibly
3. **EVO Quick Guide:** The basics of **EVO** operation
4. **EVO User Manual:** Contains the finer points of **EVO** mastery. Visit www.autelrobotics.com/support/downloads/ to download it
5. **Autel Explorer Mobile App Manual:** If you elect to download our mobile

app, visit www.autelrobotics.com/support/downloads/ to get the manual

⚠ WARNING

Make sure the aircraft and other components in the box are accounted for. Do not use incompatible components or attempt to modify **EVO** in any way inconsistent with the instructions in the official aircraft documentation.

1.2.2 Mobile App Installation (Optional)

The **Autel Explorer™** app delivers a live stream, and enhanced flight and camera controls to your mobile device.

Search for **Autel Explorer** in the App Store or Google Play, then tap **INSTALL**.



Chapter 2

Getting to Know Your Smart Drone

Now you can explore, discover and create like never before. **EVO** delivers not only advanced features like obstacle avoidance and intelligent flight modes, but also high-tech muscle that brings home a top speed of 44 mph, a 30-minute flight time and an operating distance of 4.2 miles.

In-flight performance, however, is just the start. **EVO's** stabilized 3-axis camera allows you to shoot at up to 4K/60p, and view the live feed at up to 720p on your mobile device or the remote control's built-in OLED screen.

2.1 Aircraft

EVO is a foldable quadcopter with a stabilized 3-Axis camera gimbal and an integrated HD camera.

2.1.1 Functionality Description

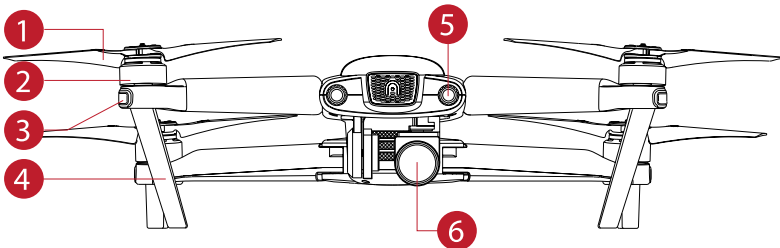

Front Side

- ① Propellers
- ② Motors

- ④ Landing Gear
- ⑤ Forward Vision System

③ Front LED Indicators

⑥ Camera Gimbal

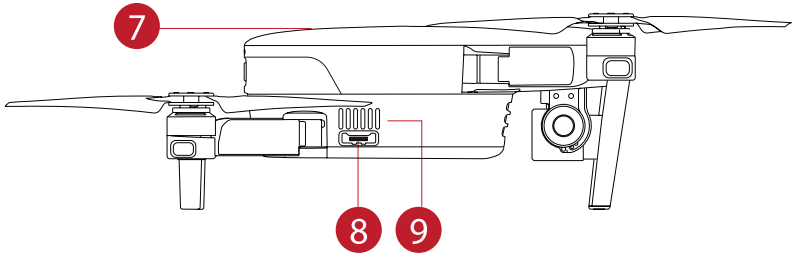

Right Side

⑦ Aircraft Battery ( 6)

⑨ Fan Exhaust

⑧ Micro-SD Card Slot

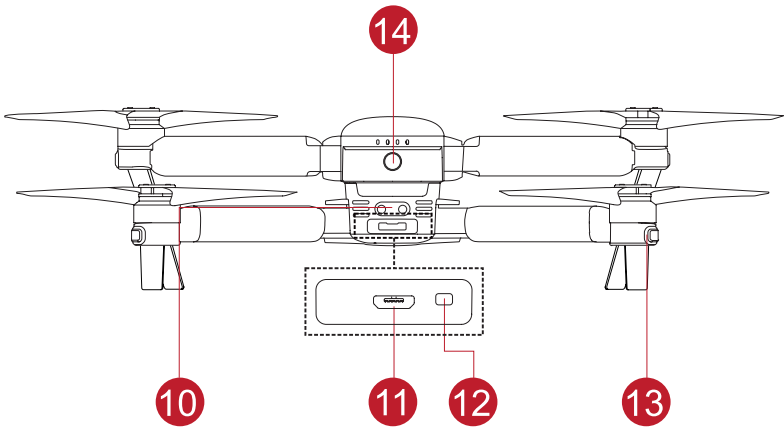

Rear Side

⑩ Rear Avoidance Sensor

⑬ Rear LED Indicators

⑪ Micro-USB Port

⑭ Power Button

⑫ Remote Control Pairing Button/Pairing Indicator

NOTE

There is a protector on the back designed to protect the **Micro-USB Port** and **Remote Control Pairing Button/Pairing Indicator**, remember to push it back when flying the aircraft.

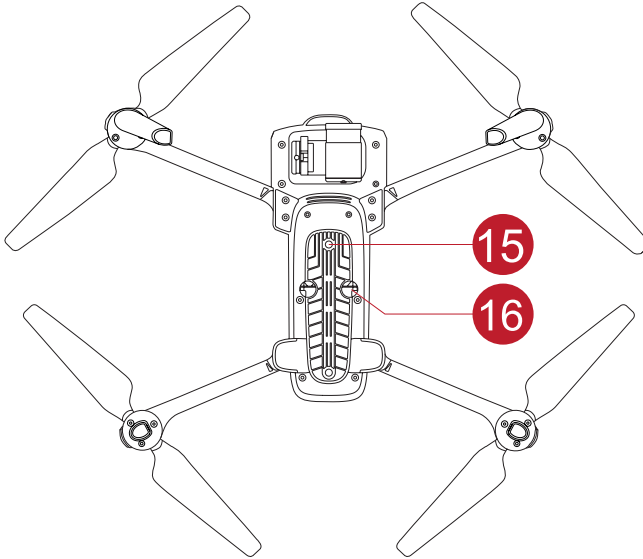

Bottom Side

⑮ Downward Vision System

⑯ Ultrasonic Sensor

2.1.2 Flight LED Indicators

An LED indicator is located on the end of each aircraft arm. The front LEDs will light up solid red to help you identify the direction of the **EVO's** nose. The rear LEDs will display the current flight status of the aircraft. Refer to this chart to confirm the meaning of the different status indicators.

Indicator Key:

Solid Light

Slow Flashing: Flashes once every two seconds

Fast Flashing: Flashes two times per second

Double Flashing: Flashes two times then pauses and repeats

Alternate Flashing: Alternate among different colors

Color Key:

R Red Color

G Green Color

Y Yellow Color

Example: "R - Solid Light"

Solid Red Light

Definitions of Flight LED Indicator Status

Normal Status

RGY - Alternate Flashing	System self-test is activated
YG - Alternate Flashing	The aircraft is warming up
G - Slow Flashing	The aircraft is in GPS mode

Warning

Y - Slow Flashing	The aircraft is in ATTI mode
Y - Fast Flashing	No connection between the aircraft and remote control
R - Slow Flashing	Low Battery Warning
R - Fast Flashing	Critically Low Battery Warning
R - Solid Light	Critical problems, IMU error
RY - Alternate Flashing	Abnormal compass, calibration is required / Magnetometer interference

Compass Calibration

Y - Fast Flashing	Be ready to calibrate the compass / The aircraft is calibrating
G - Solid Light	Calibration is successful
R - Solid Light	Calibration is failed

2.1.3 Aircraft Battery

EVO's custom-designed, rechargeable Li-Po battery with a capacity of 4300mAh can provide up to 30 minutes of continuous flight with a full charge. It should be charged exclusively using the supplied charger.

● Basic Functions

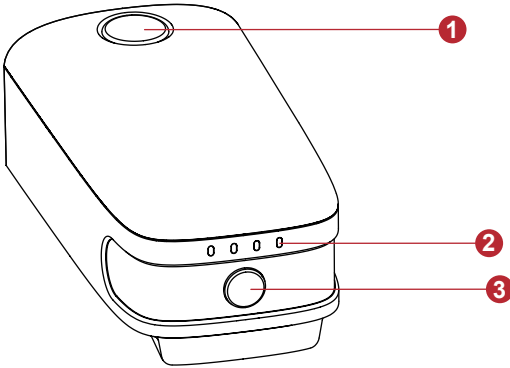

Aircraft Battery

- ① Removal Button
- ② Capacity Level Indicators
- ③ Power Button

➤ Turning On the Battery

Make sure the battery is off before attaching it to the aircraft. After attaching it, press and hold the **Power Button** for 3 seconds. The capacity level indicators will display the current battery level.

➤ Turning Off the Battery

Press and hold the **Power Button** for 3 seconds to turn off the battery. If the battery is attached on the aircraft, the LED1 and LED 4 will flash for 5 times to indicate shutdown. Remove the aircraft battery from the aircraft after turning off all the **Capacity Level Indicators**.

➤ Checking the Battery Level

To check the battery level without powering it on, press the **Power Button** for 1 second, then release it quickly. The LEDs will display the current battery level as shown below.

<i>Battery Level Indicator Status While Discharging</i>				
87.5%~100%	75%~87.5%	62.5%~75%	50%~62.5%	37.5%~50%
25%~37.5%	12.5%~25%	0%~12.5%		
- Solid Green Light - Flashing Green Light - No Lights				

● Additional Functions

The smart functions listed below will give you a full understanding of the aircraft battery and how to protect and preserve the battery life.

- **Storage Self-Discharge Protection:** In order to prevent damage, after the battery has been idle for 6 days and the voltage is higher than 12V, the battery will discharge automatically to approximately 70% of total power. This is the default setting, and the discharge process takes 2-3 days. While there's no formal indication that the battery is performing a self-discharge cycle, you may notice a slight warming of the battery, which is normal. The discharge threshold can be customized using the **Autel Explorer™** app.
- **Charging Temperature Detection:** The normal charging temperature should be between 10°C (50°F) and 45°C (113°F), the battery will stop charging if the temperature exceeds this range.
- **Overcurrent Protection:** The battery will stop charging if the charging current exceeds 8A to prevent severe damage.
- **Overcharge Protection:** Charging will stop automatically when the battery reaches full charge.
- **Balance Protection:** Balances the voltage of each battery cell to prevent overcharging or over-discharging.
- **Over-Discharge Protection:** When the battery is not in use, it will automatically disconnect the power output function once the self-discharge cycle is completed. This function is disabled during flight.
- **Short Circuit Protection:** The power supply will be cut off in the event that a short circuit is detected.
- **Power Saving Mode:** After 30 minutes of inactivity, the battery will disconnect from the power supply and enter power saving mode to retain the energy.
- **Communication:** When in use, the aircraft continuously syncs with the battery to provide real-time information including voltage, capacity, current, and temperature.
- **Ultra-Low Power Consumption Mode:** When idle for 7 days with a voltage lower than 11.7V, the battery will enter this mode in order to conserve power. It will resume normal function after being connected to the charger.

2.1.4 Gimbal & Camera

● XI-5A Camera Gimbal

The camera gimbal is engineered to minimize camera vibration and provide superior stability, with a controllable roll axis range of 0°~90°. The operating temperature is maintained at -10°C~50°C (14°F~122°F).

When the aircraft is powered up, the gimbal will automatically perform a calibration test. Use the diagram below to familiarize yourself with all the moving parts of the gimbal.

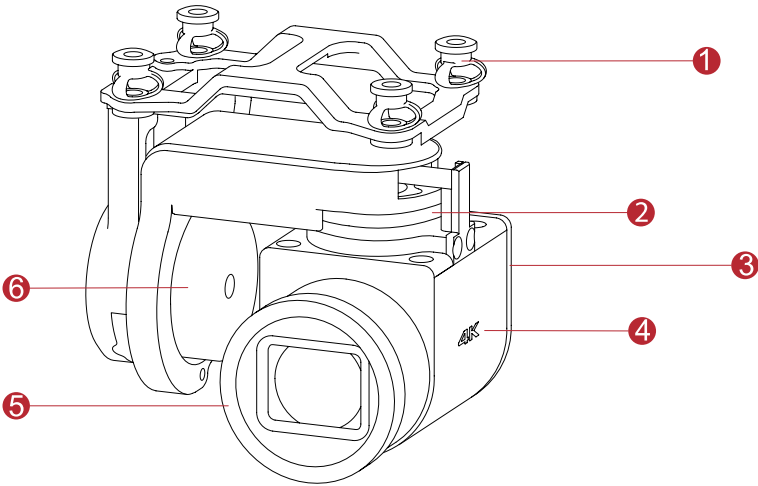

① Vibration Absorber

② Yaw Motor

③ Roll Motor

④ Camera

⑤ Filter

⑥ Pitch Motor

! IMPORTANT

- The **EVO XI-5A Camera Gimbal** is held in place with a gimbal holder to protect the gimbal from the incidental rotation — and to avoid damage when stored.
 - **Remember to remove the holder before powering up the aircraft. Failure to do so may result in damage to the gimbal motors and circuitry.**
-

The **XI-5A Camera Gimbal** has two working modes:

- **Stabilized Mode:** The gimbal's orientation stays aligned with the aircraft's nose, but keeps the horizon even as the aircraft tilts.
- **FPV Mode:** The gimbal is continually synchronized with the aircraft's movement — including rotation and tilt — to create a first-person viewing experience during the flight.

● Camera

EVO's 4K UHD camera supports a variety of shooting modes, including:

- Single Shot
- Burst Shooting
- AEB
- Time-lapse

The camera saves photos in DNG or JPG formats, and records videos in MOV or MP4 formats. A high-definition live feed from the camera can be displayed on your remote control's screen, or with improved image quality on your mobile device using the mobile app.

➤ Using a Micro SD Card

Before turning on the aircraft, insert a micro SD card into the port illustrated below. **EVO** supports SD card capacity up to 128GB. If you plan to shoot HD video, we recommend using a Class 10 or UHS-1 micro SD card.

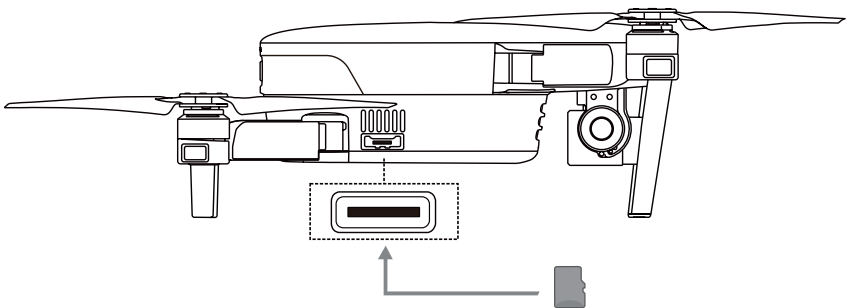

⚠ WARNING

To prevent file loss, always power off the aircraft before removing the micro SD card.

➤ **Transferring Files to Your Computer**

To transfer photos and videos to your computer, connect it to the aircraft via the **Micro USB Port** as shown below.

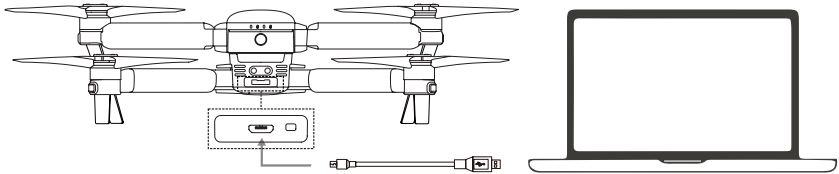

2.1.5 Built-in Smart Flight System

EVO delivers stable and user-friendly flight control via its built-in **Smart Flight System**. The system enables a variety of advanced functions, including **Go Home**, **Failsafe**, and the **Starpoint™ Positioning System**, and operates using the modules described below.

<i>Smart Flight System Modules</i>	
Module	Description
IMU	A 3-axis gyroscope and 3-axis accelerometer measures acceleration and angular velocity. Automatic IMU calibration is performed when the aircraft is powered on.
Compass	Measures geomagnetic field and provides heading reference for the aircraft.
GNSS Receiver	Receives GNSS (GPS/GLONASS) signals to determine the latitude, longitude, and altitude.
Barometer	Measures atmospheric pressure to determine the altitude of the aircraft.
Ultrasonic Sensors	Measures the distance between the aircraft and ground.

Binocular Vision System	Enables forward and downward binocular vision.
Rear Avoidance Sensor	Infrared transmitter/receiver on the rear of the aircraft that scans for potential obstacles.

● Flight Modes

EVO's 2 flight modes help you pilot the aircraft according to GPS availability and flying conditions.

<i>Flight Modes</i>	
Flight Modes	Description
GPS Mode	GPS Mode is activated if the aircraft detects proper GNSS signals. GPS works with the Forward and Downward Vision Systems to locate and navigate obstacles, provide stable and smooth flight maneuvers, and enable safety features like Go Home and Failsafe .
ATTI Mode	ATTI Mode is activated when the GPS signal is weak, and lighting conditions are insufficient for the vision systems. Obstacle avoidance features are disabled, and the aircraft uses only its barometer for controlling altitude.

2.1.6 Smart Flight Features

● Go Home

The **Go Home** function can be enabled when good GPS signal is available. To manually activate the **Go Home** process, press and hold the **Go Home Button** () for 3 seconds on the remote control. Once the aircraft receives this command, it will return automatically and land at the present home point.

EVO can detect and avoid obstacles on its flight path using **Forward Vision System**. The remote control's function will be disabled while the aircraft returns to the home point, but you can reactivate it by pressing the **Pause Button** ().

WARNING

If the **Forward Vision System** is disabled during the **Go Home** period, remember to press the **Pause Button** () on the remote control to exit the **Go Home** feature and regain control of the aircraft.

! IMPORTANT

- The default **Go Home** altitude is 30 meters. If you activate **Go Home** when the aircraft is lower than that, it will rise to 30m before returning. Learn how to adjust the **Go Home** altitude in the **App Manual**.
 - If the **Go Home** function is activated within a 10m radius from the home point, the aircraft will automatically descent and land.
-

● Failsafe

The **Failsafe** function is designed to help **EVO** automatically return home or land on-site when necessary.



➤ Communication Lost

Failsafe will be triggered 3s after the communication between your aircraft and remote control gets lost.

If GPS is available when activating the **Failsafe** function, the aircraft will automatically use the **Go Home** function. Otherwise, it will land from its current position. When the remote control signal returns, you can still press the **Pause Button** () to regain control of the aircraft.

➤ Low Aircraft Battery Level

Failsafe will also be activated if you meet either of the following low battery conditions.

- A. **EVO** continually calculates the required battery level for the aircraft to return to the home point. A notice on the **Autel Explorer™** app will appear when the battery level reaches the minimum level required for the aircraft to return to the home point. **Failsafe** will be activated, and **EVO** will automatically fly home. Again, you can regain control of the aircraft by pressing the **Pause Button**() during the **Go Home** process.
- B. When **EVO**'s battery level reaches the 25% threshold, you'll receive a **Low Battery Warning** and **Failsafe** will be activated, after which the aircraft will automatically return home. If you retake control of the aircraft, when the battery reaches 15%, you'll receive a **Critically Low Battery Warning**, and the aircraft will automatically land in its current position. In the case of an emergency, you may press the **Pause Button**() to halt the landing and fly it to the nearest possible safe landing site.

 **NOTE**

- If the aircraft is within 50 horizontal meters from the home point when your aircraft battery level reaches 25% (**Low Battery Warning**), the aircraft will not perform the **Go Home** procedure.
 - If GPS is unavailable when **Failsafe** is activated at **Low Battery Warning**, the aircraft will not execute the **Go Home** procedure. Instead, the aircraft will stay in your control and only proceed to land automatically when the battery reaches 15% (**Critically Low Battery Warning**).
-

● Landing Features

➤ Landing Protection

When the aircraft arrives above the home point, **Landing Protection** functionality will detect the ground conditions below. **EVO** will land automatically if the ground is level and flat. If not, it will hover at the current location to wait for the next command.

➤ Accurate Landing

EVO will scan and match the terrain features if **Accurate Landing** function is active, it will land as close as possible to the takeoff point once the current terrain matches the takeoff point terrain.

❗ IMPORTANT

- **EVO** records the takeoff point as the default home point. **Accurate Landing** is available only when the home point has not been refreshed during the flight.
 - Choose an open and well-lit area (such as a lawn) as your takeoff point.
 - When **Accurate Landing** is preparing to land the aircraft, make sure that conditions at your takeoff point haven't changed.
-

NOTE

Landing Protection and **Accurate Landing** can be enabled using the app. Instructions for these functions are available in the **App Manual**.

● Starpoint™ Positioning System

EVO Starpoint™ Positioning System

functions through **Binocular Cameras**① and two **Ultrasonic Sensors**② on the bottom of the aircraft. The sensors calculate the current height of the aircraft using ultrasound, and the camera obtains location information via image analysis. When flying indoors or in another environment where a GPS signal is unavailable, **Starpoint™ Positioning System** allows the aircraft to hover in place precisely.

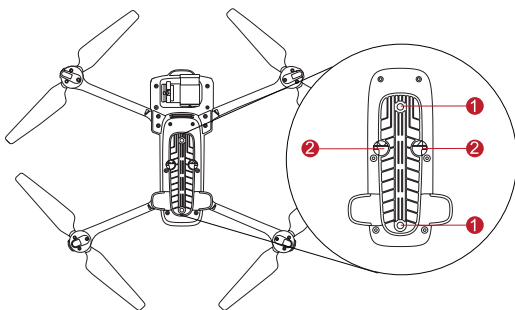

NOTE

- The **Starpoint™ Positioning System** is activated by default when the aircraft is powered on.
- It works both in **GPS** and **ATTI** modes.
- It is only enabled when the aircraft is between 0.5m and 10m above the surface.

● Forward Vision System & Rear Avoidance Sensors

The **Forward Vision System** on the front of the aircraft uses image data to calculate the distance between the aircraft and potential obstacles. The system will halt **EVO's** forward progress when an obstacle is detected. Infrared sensors detect motion and measure any heat being emitted by potential obstacles to the rear of the aircraft.

TIPS

- Always keep the binocular camera lens clean.
- When the **Starpoint™ Positioning System** is activated, don't use other 40KHz ultrasonic devices nearby, such as ultrasonic rangefinders, fault detectors, cleaners or welding machines.

! IMPORTANT

The performance of the **Starpoint™ Positioning System** and **Forward Vision System** are affected by the brightness and texture of the surface over which the aircraft is flying. The ultrasonic sensors may not function accurately above sound-absorbing materials. Because of this, we recommend that you avoid flying **EVO** over surfaces that are:

- Monochrome
- Highly reflective, such as water
- Extraordinarily dark or bright
- Subject to frequent lighting changes
- Made of closely repeating patterns, such as tiles
- Absorbent of sound waves, such as thick carpet
- In motion, such as roads with heavy traffic

Also, avoid flying at high speeds while at low altitude: We caution against flying faster than 8 meters per second at a 2-meter height, or over 4m/s at a 1-meter height.

2.2 Remote Control

EVO has an unobstructed range of up to 7km under optimum conditions. The remote control supports live video downlink, and functions without a paired mobile device. The video downlink system and aircraft remote control system operate at 2.4GHz or 900MHz, depending on what you select. The 3.3-inch OLED screen displays live video feed, battery level, GPS signals, flight speed, and more.

2.2.1 Functionality Description

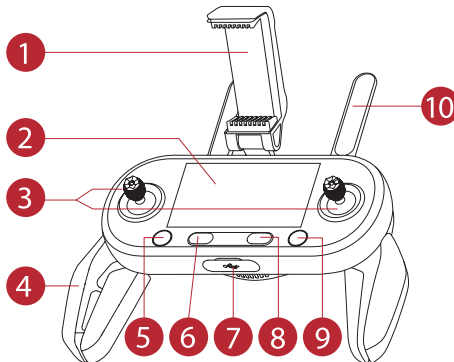

① Mobile Device Holder	With a 180° adjustable viewing angle for optimum visibility
② Flight Information Panel	Displays the flight status, warning messages and real-time live view
③ Command Sticks	Control the orientation and movement of the aircraft
④ Hand Grips	These are foldable to allow for compact storage
⑤ Take-off/Landing Button	Commands the aircraft to take off or land
⑥ Power Button	Press and hold the button for 3 seconds to turn on/off the remote control
⑦ USB Ports	The two ports can be used for charging or connecting to your mobile device
⑧ Pause Button	Tells the aircraft to pause autonomous flight operations and hover in place (press it a second time, and autonomous mode will resume)
⑨ Go Home Button	Commands the aircraft to return to the home point
⑩ Antennas	Communicate with the aircraft at 2.4GHz or 900MHz

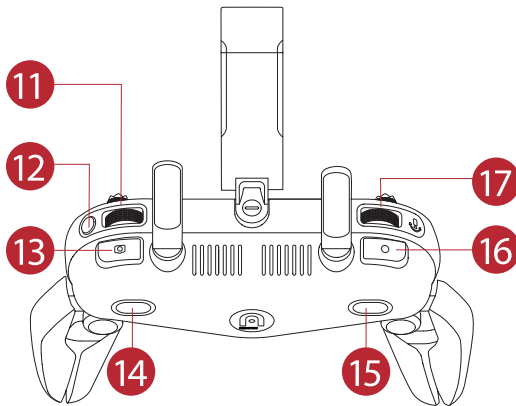

⑪ Screen Navigation Dial	Scrolls the OLED screen
⑫ Screen Navigation Button	When the mobile device is disconnected, press this button for one second to enter/exit the Image Transmission screen on the remote control
⑬ Shutter Button	Takes photos. When Burst Mode is turned on, several images will be taken with one press. More details on this function can be found in the App Manual

⑭ Customizable Button A	The function is customized by yourself using the mobile app
⑮ Customizable Button B	The function is customized by the user using the mobile app
⑯ Record Button	Press the button to start or stop recording video
⑰ Gimbal Pitch Dial	Controls the pitch angle of the camera gimbal

2.2.2 Live View Panel

● Flight Information Panel

When the video link has been connected, the main interface will appear as below.

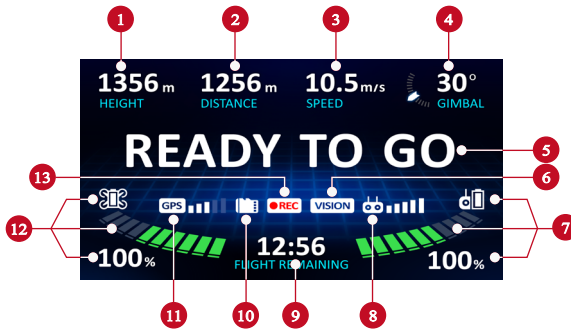

① Flight Altitude	Aircraft altitude relative to the home point
② Flight Distance	Horizontal distance between the aircraft and home point
③ Flight Speed	Current speed of the aircraft
④ Tilt Angle	The camera's angle tilted by the gimbal (range: 0°~90°)
⑤ Flight Status Bar	Displays real-time flight status and current flight mode
⑥ Vision System	Displays when the Vision Obstacle Avoidance System is enabled <ul style="list-style-type: none"> • Displays the current battery level
⑦ Remote Control Battery	<ul style="list-style-type: none"> • Green bars indicate normal battery (approximately 11%-100%) • Red bars indicate low battery (approximately 10%)

⑨ Remote Control Signal	Shows the current signal strength
⑩ Remaining Flight Time	Estimates how much longer the aircraft can stay in the air
⑪ Micro SD Card	Indicates that the Micro SD Card is installed and available
⑫ GPS Signal	Indicates the signal strength of nearby GNSS satellites
⑬ Aircraft Battery	<ul style="list-style-type: none"> • Displays the current battery level • Green bars indicate normal battery • Orange bars indicate low battery • Red bars indicate critically low battery (you can set the battery level threshold using the Autel Explorer™ mobile app)
⑭ Record Status	Indicates if you are currently recording

● Image Transmission Mode

Press the **Screen Navigation Button** on the remote control when you want to enter the **Image Transmission Mode**. Then follow these steps:

1. Scroll the **Screen Navigation Dial** to highlight the different setting options.
2. Press the **Screen Navigation Dial** instructed on the screen to enter the related option.
3. Scroll the **Screen Navigation Dial** again to set different values.
4. Press the **Screen Navigation Dial** to confirm this value or press the **Screen Navigation Button (DISP)** to go back.
5. Press the **Shutter Button** to take photos.
6. Press the **Record Button** to start or stop recording videos.

➤ Image Transmission View

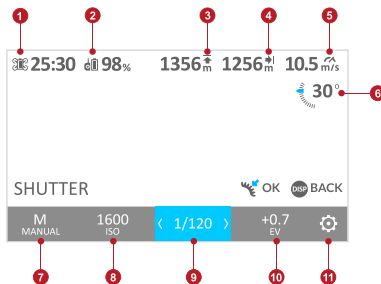

① Remaining Flight Time	Estimates how much longer the aircraft can stay in the air
② Remote Control Battery	Displays the battery level remaining
③ Altitude	Displays the aircraft altitude relative to the home point
④ Distance	Displays the horizontal distance between the aircraft and the home point
⑤ Flight Speed	Displays the current speed of the aircraft
⑥ Gimbal Angle	The number in the picture indicates the angle of the gimbal in degrees. The blue arrow will rotate as the gimbal angle changes
⑦ Exposure Mode	Set your camera to in order to adjust your ISO and shutter speed, or choose Auto and let the camera do the work for you <ul style="list-style-type: none"> • Manual: The EV setting will be disabled • Auto: The ISO and shutter speeds will be disabled
⑧ ISO	This setting adjusts the images sensor to the sensitivity to light. A lower ISO works on bright sunny days, and a high ISO is great for low light scenarios but will increase the noise/grain in the image.
⑨ Shutter	Fast shutter speeds let you capture action in motion; longer shutter speeds are helpful in low-light scenarios
⑩ EV	The Exposure Value (EV) is a combination of both the ISO and shutter speed, and is used when the camera is set to Auto . Adjust the EV to brighten or darken the exposure
⑪ Settings	Press this button to access the Advanced Settings page

● Settings

➤ Basic Instruction

1. Scroll the **Screen Navigation Dial** to highlight different setting options on the top of the screen.
2. Press the **Screen Navigation Dial** instructed on the screen to enter the related option or press the **Screen Navigation Button (DISP)** to go back to the last step.
3. Scroll the **Screen Navigation Dial** again to set different values.

- Press the **Screen Navigation Dial** to confirm this value or press the **Screen Navigation Button (DISP)** to go back to the last step.

➤ Camera Settings

Camera (* =default value)	
Photo Mode	*Single, Burst (3/*5/7/14), Time Lapse (2/*5/7/10/20/30/60), AEB (*3/5)
Photo Format	*JPG, RAW, JPG+RAW
Video Resolution	*4K (3840x2160), 4K+(4096x2160), 2.7K (2720x1530), 1080P (1920x1080), 720P (1280x720)
Video Frame Rate	240FPS, 60FPS, 48FPS, *30FPS, 24FPS
Video Standard	*NTSC, PAL

➤ Flight Control Settings

- Turn **Novice Mode** on/off
- Choose the **Speed Limit** value
- Adjust the **Go-Home Altitude**, **Altitude Limit**, and **Distance Limit**

NOTE









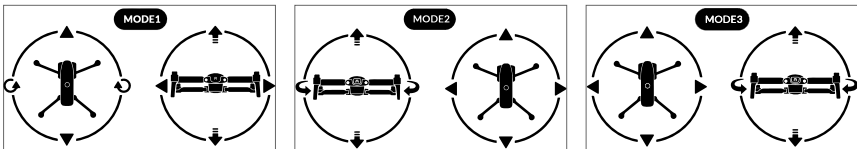

When **Novice Mode** is engaged, the aircraft will operate with a fixed maximum **Go-Home Altitude** (98ft), **Speed Limit** (11mph), **Altitude Limit** (98ft), and **Distance Limit** (328ft). You can't enter these limit settings even press the **Screen Navigation Dial**.

➤ Remote Control Settings

1. Command Stick Mode

Mode 1, **Mode 2** and **Mode 3** allow you to control the aircraft according to your preferences, as illustrated below.



Indicator Icons		Aircraft Movement	
		Ascend	Descend
 / 	 / 	Nose rotates left	Nose rotates right
		Move forward	Move backward
		Move left	Move right

2. Remote Control Calibration

Refer to **Section 3.2.3** ([📄 27](#)) for detailed calibration instructions.

➤ Vision Settings

Access these settings to turn **Visual Obstacle Avoidance** on/off and select **Show Radar Map**.

➤ General Settings

- Language:** Select the displayed language.
- Units:** Choose the unit of measurement displayed in **Flight Control Settings:** Metric (m/s) or Imperial (mph).
- Gimbal Mode:** Choose **Stabilized Mode** or **FPV Mode**.
- Format SD Card:** Use this to ensure that your SD card is in an acceptable format.
- Reset Camera:** Use this to restore all the camera settings to default.

2.2.3 Indicator Lights

A single LED indicator is located under the remote's **Power Button** ().

	Solid Light	R	Red Light
	Flashing Light	G	Green Light
	No Lights	Y	Yellow Light

Example: “R-●” SOLID RED light



G-●	Indicates sufficient battery level when the remote control is in use, or that a full charge has been reached when charging
G-◎	Indicates that the remote control is charging while powered on
Y-●	Low battery warning
R-●	Indicates that the remote control is charging while powered off
R-◎	Firmware is upgrading
○	The remote control is powered off or has reached full charged while powered off

2.2.4 Remote Controller Buzzer Alerts

The table below describes the various buzzer alerts and their corresponding meanings.

<i>Remote Controller Buzzer Alerts</i>	
Aircraft Low Battery Warning (about 25%)	1 quick beep every second (lasts for 5s), with 2 remote control vibrations
Aircraft Critically Low Battery Warning (about 15%)	5 quick beeps every second (last for 5s), with 5 remote control vibrations
Remote Control Low Battery Warning (10%)	1 quick beep every second (lasts for 5s)
Remote Control Critically Low Battery Warning (5%)	5 quick beeps every second (last for 3s), with two remote control vibrations
Aircraft & Remote Control Communication Lost	2 quick beeps every second (last for 5s), with 1 remote control vibration
Video Link Disconnected	3 quick beeps in 1 second
Compass Interference	3 beeps with 3 remote control vibrations
Standby Notification	3 beeps every 15 minutes of inactivity

Chapter 3

Preflight Preparation

EVO features a user-friendly design and comes fully assembled out of the box. In order to ensure safe drone operation, please read and understand the instructions and warnings below before your first flight.

3.1 Battery Preparation

3.1.1 Aircraft Battery Installation

1. Power off the battery before installing it.
2. Insert the battery into the battery compartment as shown on the right.
3. The battery will firmly click in place.

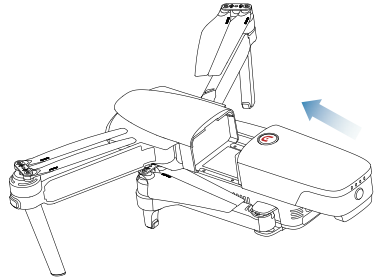

3.1.2 Aircraft Battery Removal

1. Power off the aircraft battery before removal.
2. Press and hold the top button () located on the battery and pull it out slowly.

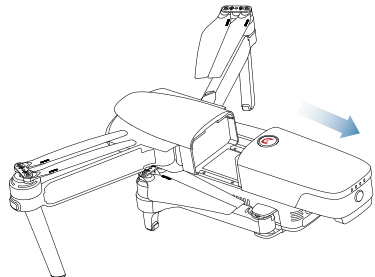

3.1.3 Charging

The aircraft battery and remote control can be charged simultaneously using the supplied charger. There are two connectors attached to the charger's adapter block. As shown below, the fixed one goes with the aircraft battery, and the USB cable is used to charge the remote control.

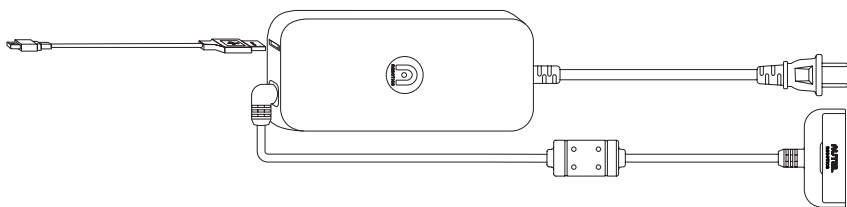

➤ Charging the aircraft and remote control

1. **Aircraft Battery:** Plug the charging connector into the battery's charge port, as shown on the right.

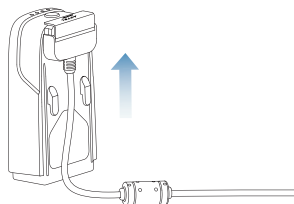

❗ IMPORTANT

Make sure to fully charge the aircraft battery before flight.

2. **Remote Control:** Open the protector on the USB port and plug in the provided charging cable.

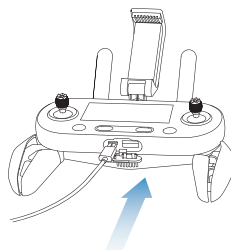

3. **Charger:** Plug it into a power outlet.

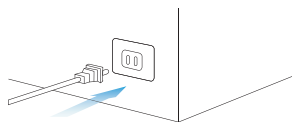

- **Capacity Level Indicators:** The LEDs on the aircraft battery will illuminate from left to right to indicate the current battery level during the charging cycle, and will turn off when the battery is fully charged.

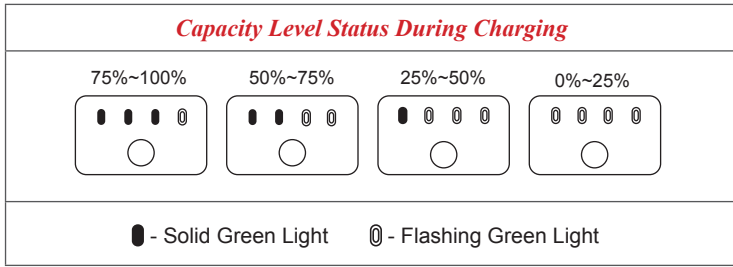

➤ **During Charging:** The **Power Button** () on the remote control will be green when it is powered on, or red when it's powered off. You can monitor the charging process on the **Flight Information Panel**. You'll hear 2 beeps when charging is complete.

- When charging is completed, disconnect the charger and the aircraft battery/remote control.

NOTE

- Always fly with a fully charged aircraft and remote control battery.
- It takes approximately 80 minutes to fully charge the aircraft battery, and 180 minutes to charge the remote control.

3.2 Remote Control Preparation

3.2.1 Unfolding the Remote Control

The remote control is folded in the package. Unfold the **Mobile Device Holder**, **Antennas**, and **Hand Grips** carefully before use to prevent damage and to ensure optimal range of flight.

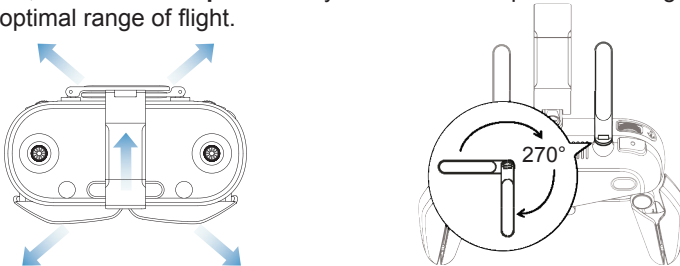

NOTE

The antennas can be rotated 270 degrees as shown in the diagram.

● Positioning the Antennas

Vertically align the antennas in parallel with each other, as shown below.

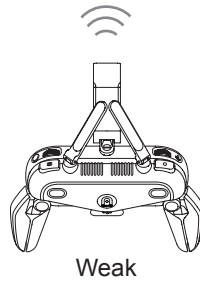
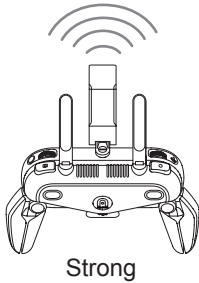

3.2.2 Powering Up/Off the Remote Control

● Powering Up

Press and hold the **Power Button** () for 2 seconds until you hear a short beep. The **Flight Information Panel** will light up and cycle through an initial verification test.

IMPORTANT

Always turn on the remote control first before powering up the aircraft.

● Powering Off

Press and hold the **Power Button** () for 2 seconds until you hear a short beep.

IMPORTANT

Always power off the aircraft before turning off the remote control.



NOTE

When not connected to the aircraft, the remote control makes an alert sound after 15 minutes of inactivity, and turns off automatically after 18 minutes.

3.2.3 Remote Control Calibration

If the **Command Sticks** are abnormal (For example, if the remote control falls on the ground accidentally, or the aircraft's flight direction does not match control

inputs), it is recommended to calibrate the remote control. You can calibrate your remote control according to the following steps, or by using the mobile app (Refer to the **App Manual** for more information).

1. Turn off the remote control. Press and hold the **Power Button** () and **Take-off/Landing Button** () simultaneously until the screen appears as shown on the right. The four crossed bars represent the left and right **Command Sticks**. The horizontal bar at the top is the **Gimbal Pitch Dial**.
2. Release both **Command Sticks** and the **Gimbal Pitch Dial** naturally to the central position. The three middle rounds on the remote control calibration screen will be highlighted successively.
3. Push and hold the **Command Sticks** in every possible direction until you hear a beep each time. Then turn the **Gimbal Pitch Dial** clockwise until you hear a beep, then again counterclockwise.
4. Calibration is complete when all the bars on the screen are highlighted.

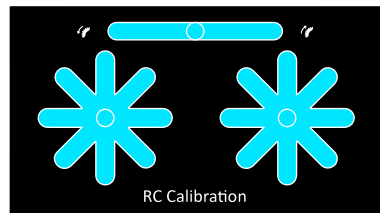
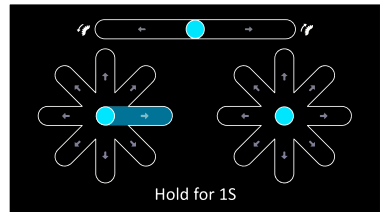
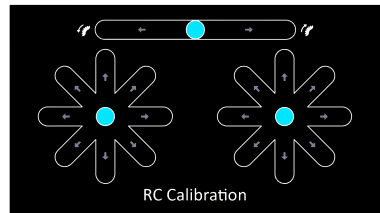
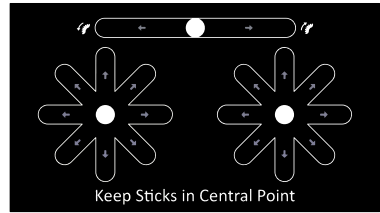

3.2.4 Pairing the Aircraft & Remote Control

The remote control and aircraft come paired out of the box. When you need to pair your **EVO** and remote control again — such as after pressing the **Remote Control Pairing Button** on the aircraft — follow these steps:

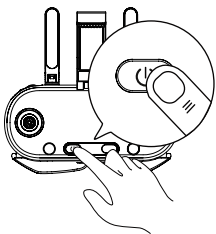

1. Turn **off** the remote control.

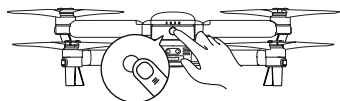

2. Remove the gimbal guard first then turn **on** the aircraft.

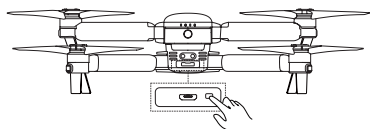

3. Press and hold the **Remote Control Pairing Button** for about 3 seconds. The **Pairing Indicator** will flash quickly, indicating the aircraft is ready to pair with the remote control.



4. Press and hold the **Power Button** (⏻) and **Go Home Button** (🏠) simultaneously for 2 seconds until “Autel” appears on the **Flight Information Panel**. The **Pairing Indicator** will turn off once your pairing is successful.

NOTE

You may also use the app to pair the aircraft and remote control. The instructions are available in the **App Manual**.

3.3 Aircraft Preparation

3.3.1 Unfolding the Aircraft

● Removing & Reinstalling the Gimbal Holder

Always remove the gimbal holder before powering up the aircraft. Slowly pull out the attached gimbal holder, as shown in the diagram.

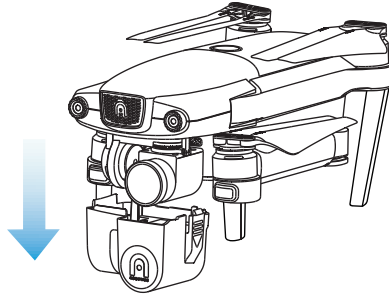

After using the aircraft, reinstall the gimbal holder in order to protect the gimbal from damage.

● Unfolding the Arms & Propellers

- Always unfold the arms and propellers before powering on the aircraft.
- Unfold the front arms first, then the rear ones.

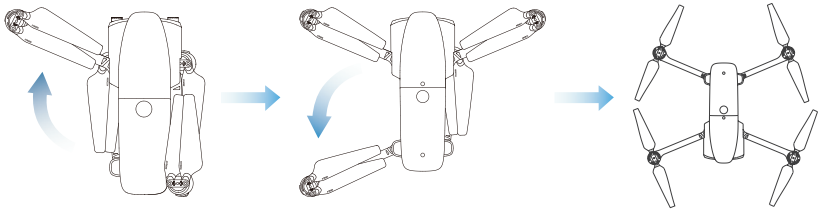

! IMPORTANT

Power off the aircraft before folding it. Fold in the rear arms and propellers first, then the front.

3.3.2 Propellers Installation

⚠ WARNING

Power off the aircraft before attaching or detaching propellers.

! IMPORTANT

Be sure to wear protective gloves when assembling or detaching propellers.

Legends

 Lock Direction: Fasten the propeller by rotating it as indicated.

 Unlock Direction: Unfasten the propeller by rotating it as indicated.

 Black-coded propeller > Pairs with > Black-coded motor

 Orange-coded propeller > Pairs with > Orange-coded motor

● Attaching the Propellers

1. Verify the aircraft is powered off.
2. Locate and match the propeller to each motor.
3. Press each propeller down firmly and rotate in the lock direction to securely attach the propeller.

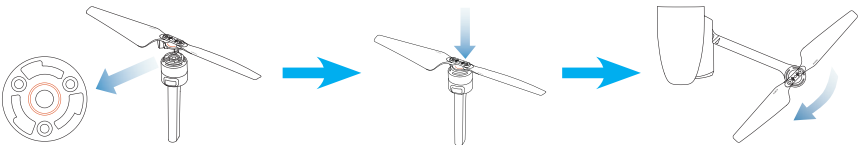

● Detaching the Propellers

1. Power off the aircraft.
2. Press each propeller down firmly and rotate in the unlock direction to detach the propeller.

! IMPORTANT

- Before flight, double-check and make sure every propeller is securely attached.
 - Never fly with broken or damaged propellers.
 - Don't touch the propellers or motors while they're spinning.
 - Always remove the propellers before testing the motors.
-

3.3.3 Compass Calibration

The compass is calibrated out of the box, typically making user-calibration unnecessary. If you experience compass error warnings, or the aircraft's flight direction does not match control inputs, or you fly the aircraft at a very long distance from your calibration position, follow the steps below to calibrate it.



WARNING

The compass is very sensitive to electromagnetic interference causing compass error and poor flight. If you find the compass abnormal after calibration, move the aircraft to another location and try again.

When calibrating the compass, remember to:

1. Set up in an open outdoor area.
2. Stay clear of all sources of magnetic interference, like magnetite or the steel reinforcement found in concrete. Proximity to large structures may also result in reduced calibration.
3. Stay well clear of underground and overhead power lines.
4. Remove all ferromagnetic materials (e.g., keys, magnetic jewelry).
5. Remove electronic devices that might interfere with the calibration (e.g., mobile devices, the remote control).

● Calibration Procedure

1. Start the calibration process by pressing the **Take-off/Landing Button** () and **Go Home Button** () on the remote control simultaneously for 3 seconds. The **Rear LED Indicators** on the aircraft will flash yellow when you initiate the calibration process.
2. Hold the aircraft horizontally and rotate it until the **Rear LED Indicators** on the aircraft turn solid green, indicating this step has been completed successfully.
3. Hold the aircraft vertically with the nose facing downward and rotate it until the **Rear LED Indicators** on the aircraft turn solid green, indicating that the calibration is successful.

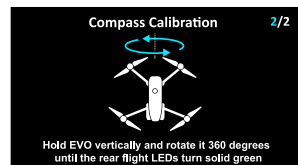
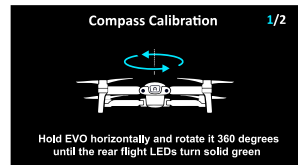

NOTE

- If the calibration is unsuccessful, the **Rear LED Indicators** on the aircraft will illuminate solid red. In this case, repeat the above steps.
 - You can also calibrate the compass using the **Autel Explorer™** app. Find out how in the **App Manual**.
-

Chapter 4

Flight Operations

4.1 Preflight Checklist

Follow these steps to carry out a full preflight checkup:

- Fully charge the **EVO** aircraft battery, remote control, and your mobile device
- Remove the gimbal holder
- Make sure the propellers are in proper condition and are correctly attached
- Position the antennas on the remote control so as to get the best possible transmission quality
- Pair the aircraft and remote control (and your mobile device, if you're using it)
- Ensure that the firmware has been updated to the latest version
- Make sure you are familiar with the flight controls
- Double-check that your flight area is open and unobstructed
- Check the weather, including air temperature and wind speed
- Check the **EVO** camera lens and sensors and clean them as needed

4.2 Remote Control & Flight Operations

There are three **Command Stick Modes** available for the aircraft: **Mode 1**, **Mode 2** and **Mode 3**. Each one controls the aircraft differently. The diagrams below employ **Mode 2**, which is the default. You can change the mode by following to the instructions in the **App Manual**.

● Basic Flight

1. Place the aircraft in an open, stand at least 5 meters clear of the rear of the aircraft.
2. Turn on the remote control.
3. Turn on the aircraft and wait for the **Rear LED Indicators** to flash green slowly.

4. Start the motors and take off using the remote control.
5. Pilot the aircraft carefully.
6. Land the aircraft, then shut down the motors.

4.2.1 Motor Start & Aircraft Takeoff

NOTE

The aircraft will not take off if the battery level is 15% or lower.

- Start the motors by holding both **Command Sticks** in position for 2 seconds:

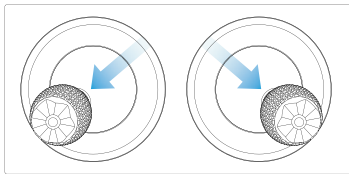

OR

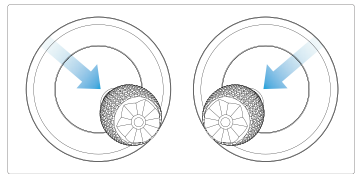

- With the motors spinning, choose either of the following takeoff commands:



Hold the Takeoff/Landing
Button for 2s

OR

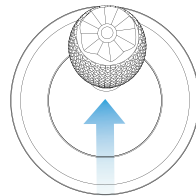

Push the Left Command
Stick slowly upward (Mode 2)

If you command the aircraft to take off pressing the **Take-off/Landing Button** () , the aircraft will automatically ascend to a height of roughly 1.5 meters.

WARNING

The motors are hot after operation. Please handle with care.

4.2.2 Command Stick Controls (Mode 2)

TIPS

For novices, we recommend moving the **Command Sticks** slowly while you get comfortable flying the aircraft.

● Left Command Stick

➤ Ascend/Descend

Command the aircraft to ascend by pushing the stick up, and descend by pressing it down.

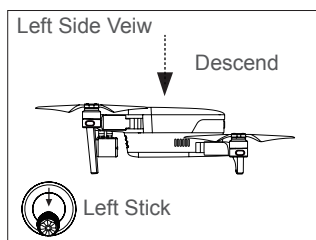
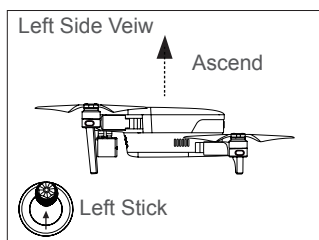

➤ Rotate Left/Rotate Right

Control the heading of the aircraft by pushing the stick left or right.

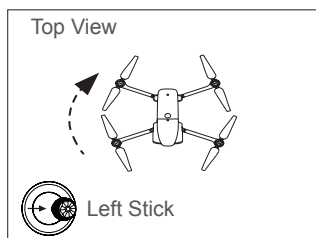
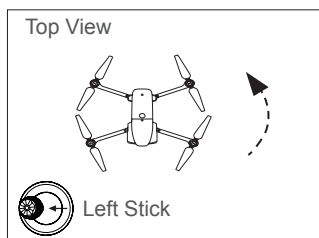

● Right Command Stick

➤ Forward/Backward

Command the aircraft to move forward or backward by pushing the stick up or down.

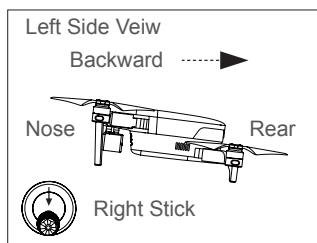
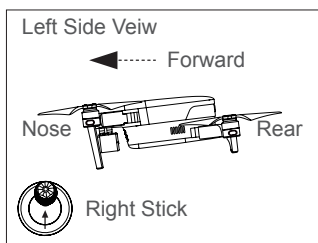

➤ Move Left/Move Right

Tell the aircraft to move left or right by pushing the stick left or right.

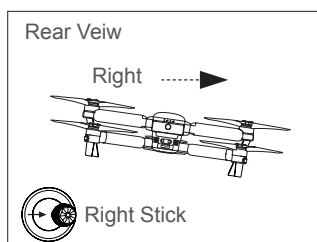
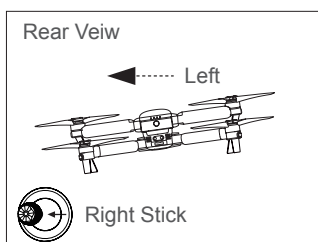

4.2.3 Landing & Motor Shutdown

EVO can be landed manually, automatically, or passively. Follow the steps below to land the aircraft by each of these means.

❗ IMPORTANT

Always land gently on a flat, level, open surface.

● Manual Landing

You can land the aircraft manually whenever and wherever you want using the **Command Sticks** on the remote control.

➤ Landing the aircraft manually

1. Find the desired position for landing the aircraft.
2. Release the **Command Sticks** when the aircraft reaches the target position to let it hover.
3. Push the **Left Command Stick** downwards slowly to land the aircraft.

➤ Shutting down the motors

Choose one of the following methods to shut down the motors after **EVO** reaches the ground:

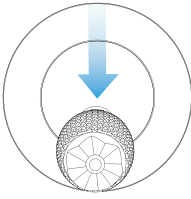

OR

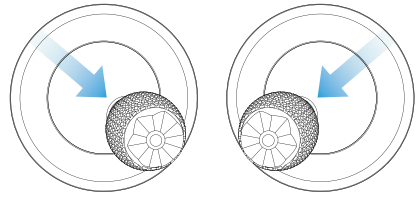

Push the Left Command Stick to the bottom and hold for 2s

Hold both Command Sticks toe-in for 2s

WARNING

The toe-in action will always shut down the motors even if **EVO** is in midair. Pay extra cautious and use this feature only in an emergency.

● Automatic Landing

Press the **Take-off/Landing Button** () on the remote control to land the aircraft automatically from its current hover position.

1. Navigate the aircraft to the target landing position.
2. Release the **Command Sticks** and let the aircraft hover.
3. Press and hold the **Take-off/Landing Button** () for 2 seconds until you hear a beep from the remote control.
4. The aircraft will descend, land and shut off its motors automatically. During descent, you can adjust the aircraft position using the **Right Command Stick**.

TIPS

During the automatic descent process, you can regain control by pressing the **Pause Button** () on the remote control.

NOTE

- Automatic landing is also available in **ATTI** mode, but you should monitor the attitude of the aircraft, as it may drift.
 - When the **Low Battery Warning** (25%) is displayed — at which the **EVO** rear LEDs will flash red and the remote control **Power Button** () will turn solid yellow — return to a safe landing point as soon as possible.
-

● **Passive Landing**

Whenever either of the following conditions is met, **Failsafe** will be triggered and the aircraft will automatically land on-site.

- The **Low Battery Warning** is activated in non-GPS environment.
- The **Critically Low Battery Warning** is activated.

Chapter 5

Maintenance & Service

5.1 Firmware Upgrade

To optimize the performance of your **EVO**, Autel Robotics will provide firmware updates on an ongoing basis. You can download the latest firmware in one package from our official website. When a firmware update is available, you will receive a prompted on the **Autel Explorer™** app after connecting it to the aircraft.

! IMPORTANT

Before updating, make sure:

- The motors are not spinning.
 - The battery levels of both **EVO** and the remote control are not less than 25%.
 - There's adequate space to store the firmware file on your camera's micro SD card.
-

● Downloading & upgrading the firmware

1. Download the all-in-one firmware upgrade package (with a .zip file extension) from Autel Robotics' official website: www.autelrobotics.com.
2. Insert the SD card into your computer and extract the downloaded file (into a .bin file extension) into your SD card. Then remove your SD card from the computer.
3. Insert the SD card into the aircraft to start the upgrade process automatically. You can check the real-time upgrade status displayed on the **Flight Information Panel**.
4. Turn on the remote control and aircraft.
5. Reboot the remote control and aircraft before use.

! IMPORTANT

- The upgrade takes about 15 minutes. Don't turn off **EVO** or the remote control, or remove your SD card from the camera during the process. Do not start the motors.
 - After upgrading, the remote control may be disconnected from the aircraft. If you need to pair them again, see **Section 3.2.4: Aircraft & Remote Control Preparation** ( 28).
-

5.2 Troubleshooting Tips

Q1. If EVO indicates a failure during self-check (Rear LED Indicators will turn solid red):

- Hardware problems detected, contact the Customer Service:
- www.autelrobotics.com/contact-us/

Q2. If the motors fail to start up:

- Verify the remote control and the aircraft are paired
- Check the remote control to make sure it's calibrated correctly
- Verify the aircraft battery level
- Make sure the compass is calibrated correctly
- Make sure GPS is available (if **Novice Mode** is active)

Q3. If takeoff fails after starting motors:

- Double-check that **EVO** is not in a known no-fly zone
- Make sure the aircraft is on a flat, level surface

Q4. If flight time is preemptively reduced:

- The most common cause of reduced flight time is a low temperature in the operating environment or increased takeoff weight

Q5. If EVO does not respond to the remote control during the pairing process:

- Make sure there are no metal objects, mobile devices or other remote controls nearby

Q6. If Video Link fails or disconnects frequently:

- Double-check that both **EVO** and the remote control are free from sources of magnetic or signal interference

Q7. If the camera is powered off during while recording video:

- Keep the micro SD card inside the camera. Restart the camera and wait until the video files are recovered to their fullest possible extent

Q8. If the video link is lost when EVO is out of sight:

- Activate **Go Home** to have the aircraft automatically return to the landing point

5.3 Storage & Maintenance

To ensure optimum performance of the product, we suggest you read and follow the maintenance instructions in this section carefully.

- Store **EVO**, the battery and the remote control in an environment that's clean, dry, cool and ventilated.
- Keep **EVO** out of sunlight when not in use.
- Dry your hands before operating the drone.
- Use a soft cloth with alcohol or a mild window cleaner to clean the lens of the camera, instead of any rough cleansers, detergent or chemicals.
- Ensure that the battery charger does not come in contact with other conductive materials.
- Avoid dropping your devices especially on a hard surface. Check it in details after any crash or impact. Contact our Customer Support team if you encounter any issues: www.autelrobotics.com/contact-us/
- Exclusively use accessories such as battery chargers authorized by Autel Robotics. Failure to do so may void warranty coverage.

5.4 Warranty

Autel Robotics (the Company) warrants to the original retail purchaser of this product, that should this product or any part thereof during normal consumer usage and conditions, be proven defective in material or workmanship that results in product failure within the valid warranty period from the date of purchase, such defect(s) will be repaired, or replaced (with new or refurbished parts or products) at the Company's option, with Proof of Purchase, without charge for parts or labor directly related to the defect(s). Some states do not allow limitation on how long an implied warranty lasts, so the above limitations may not apply to you.

The Company shall not be liable for any incidental or consequential damages arising from the use, misuse, or mounting of the device. The extent of Autel Robotics' liability under this warranty is limited to the repair and replacement provided above and, in no event, shall its liability exceed the purchase price paid by purchaser for the product. Visit www.autelrobotics.com for details of the limited periods warranted for the different parts of this product.

This warranty does not apply to:

- Batteries that cycle-charged for more than 200 times;
- Products subjected to abnormal use or environmental conditions, accident, mishandling, neglect, unauthorized alteration, misuse, improper installation or repair, or improper storage;
- Products with signs of tampering or altering of the serial number label, waterproof mark, etc.;
- Damage resulting from connection to, or use of any accessory or other product not approved or authorized by the Company;
- Defects in appearance, cosmetic, decorative or structural items such as framing and non-operative parts.
- Products damaged from external causes including but not limited to fire, water, dirt, sand, battery leakage, blown fuse, theft or improper usage of any electrical source.

5.5 Customer Service

This section contains information regarding technical support, repair service, and application for replacements or optional parts.

5.5.1 Technical Support

If you have any questions or concerns regarding our products, contact us by:

- Telephone: (844) 692-8835 (U.S.A.)
- Email: support@autelrobotics.com
- In person: Local distributors or agents

5.5.2 Repair Service

If you need to return your device for repair, please fill out and submit a repair service form on www.autelrobotics.com/warranty/ or contact our Customer Support Team at **(844) 692-8835**. You'll need to provide the following information:

- Name
- Email address
- Mailing address
- Telephone number
- Product name

- A complete description of the problem, with photo attachments
- For warranty repairs: proof of purchase
- For non-warranty repairs: Preferred method of payment

Autel Robotics' support team will review your application within 72 hours after receiving it. After a preliminary evaluation of the problem, our Customer Support Team will contact you promptly.

Chapter 6

Appendix

6.1 Regulatory Compliance & Flight Restricted Area

6.1.1 Compliance & Advisory

FCC Warning Message

Any Changes or modifications not expressly approved by the party responsible for compliance could void the user's authority to operate the equipment.

This device complies with part 15 of the FCC Rules. Operation is subject to the following two conditions: (1) This device may not cause harmful interference, and (2) this device must accept any interference received, including interference that may cause undesired operation.

FCC Radiation Exposure Statement

For EVO Series / EVO

This equipment complies with FCC radiation exposure limits set forth for an uncontrolled environment. This equipment should be installed and operated with minimum distance 20cm between the radiator & your body. This transmitter must not be co-located or operating in conjunction with any other antenna or transmitter.

For EVO Series with model EF7, SAR tests are conducted using standard operating positions accepted by the FCC/ISED with the device. When used, please keep the distance with a minimum of 10mm from the body.

Note: This equipment has been tested and found to comply with the limits for a Class B digital device, pursuant to part 15 of the FCC Rules. These limits are designed to provide reasonable protection against harmful interference in a residential installation. This equipment generates uses and can radiate radio frequency energy and, if not installed and used in accordance with the instructions, may cause harmful interference to radio communications. However, there is no guarantee that interference will not occur in a particular installation. If this equipment does cause harmful interference to radio or television reception, which can be determined by turning the equipment off and on, the user is encouraged to try to correct the interference by one or more of the following measures:

- Reorient or relocate the receiving antenna.
- Increase the separation between the equipment and receiver.
- Connect the equipment into an outlet on a circuit different from that to which the receiver is connected.
- Consult the dealer or an experienced radio/TV technician for help.

ISED RSS Warning

This device complies with ISED licence-exempt RSS standard (s). Operation is subject to the following two conditions: (1) this device may not cause interference, and (2) this device must accept any interference, including interference that may cause undesired operation of the device.

Le présent appareil est conforme aux CNR d'Industrie Canada applicables aux appareils radio exempts de licence.

L'exploitation est autorisée aux deux conditions suivantes:

- (1) l'appareil ne doit pas produire de brouillage, et
- (2) l'utilisateur de l'appareil doit accepter tout brouillage radioélectrique subi, même si le brouillage est susceptible d'en compromettre le fonctionnement.

ISED Radiation Exposure Statement

For EVO Series / EVO

This equipment complies with ISED RF radiation exposure limits set forth for an uncontrolled environment. This transmitter must not be co-located or operating in conjunction with any other antenna or transmitter. This equipment should be installed and operated with minimum distance 20cm between the radiator & your body.

For EVO Series with model EF7, SAR tests are conducted using standard operating positions accepted by the FCC/ISED with the device. When used, please keep the distance with a minimum of 10mm from the body.

Any changes or modifications not expressly approved by the party responsible for compliance could void the user's authority to operate the equipment.

6.1.2 Flight Restricted Area Illustration

The **EVO** system automatically recognizes the **Flight Restricted Area**, in which flights are limited by default. This feature guarantees pilots' safe and legal operations of the product. The flight restricted areas are divided into 2 protection categories.

Flight restrictions are enforced only within countries which require manufacturer restrictions by law. As of this writing, China is the only nation that requires manufacturers to impose flight restrictions.

 **NOTE**

The pilot is responsible for ensuring they are following all flight rules and regulations in the areas they fly.

Category I: Major airports & flight areas where drones operate at low altitudes

- **Take-off Restricted Zones (No-Fly Zones)**

These areas are set within 2.4km (based on country-imposed rules) around the midway point of specified locations.

- **Altitude Restricted Zones**

In these areas, the aircraft is only allowed to fly within limited altitudes. Depending on the government-imposed rules, from 8km to 2.4km around the location's midway point, the flight altitude decreases progressively from 120m to 10.5m.

- **Warning Zones**

Once the aircraft enters a region within 8.1 km from the central point of the airport, the app will prompt a warning message.

 **NOTE**

The aircraft will land automatically when entering any **Take-off Restricted Zones**. If the aircraft enters any **Altitude Restricted Zones**, its maximum allowable altitude will be reduced accordingly. Pay particular attention to the warning messages displayed on your app.

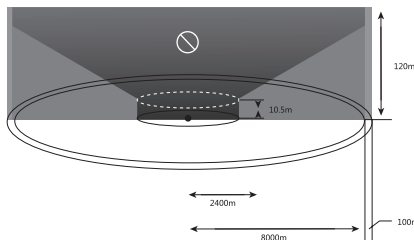

Category II: Sensitive areas & institutes such as military sites & border lines between nations

- **Take-off Restricted Zones (No-Fly Zones)**

These areas are set within 1km of the center of the specified locations where takeoff and flight are prohibited.

- **Warning Zone**

Once the aircraft enters a region within 2km from the center of the **Warning Zone**

site, the app will display a warning message.

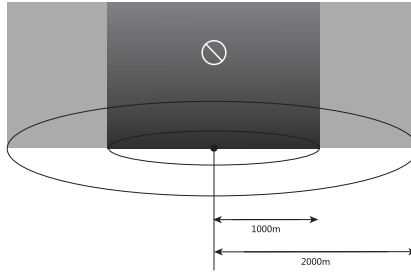

6.2 Specifications

<i>Aircraft Specifications</i>	
Max. Take-off Weight	1000g
Hover Precision	GPS+ Ultrasonic+IMU: Horizontal: $\pm 1.5\text{m}$, Vertical: $\pm 0.2\text{m}$; Vision+IMU: Horizontal: $\pm 0.1\text{m}$, Vertical: $\pm 0.1\text{m}$
Max. Yaw Rate	200 dps
Max. Inclination Angle	35 deg
Max. Ascent/Descent Speed	Ascent: 5m/s Descent: 3m/s
Max. Horizontal Speed	20 m/s
Diagonal Wheelbase	338 mm
Propeller Size	8.3 inches
Video Link Frequency	2.4GHz~2.4835GHz
	902MHz~928MHz
Receiver Frequency	2.4GHz~2.4835GHz 902MHz~928MHz
Flight Modes	GPS Mode, ATTI Mode
Operating Environment Temperature	0°C~40°C (32°F~104°F)
Storage Temperature	-10°C~40°C (14°F~104°F)
Weight (Battery & Propellers included)	863 g

<i>Aircraft Battery Specifications</i>	
Battery Type	Lithium-Polymer
Capacity	4300 mAh

Battery Voltage	11.4 V
Charging Environment Temperature	10°C~45°C (50°F~113°F)
Discharging Environment Temperature	-20°C~60°C (-4°F~140°F)
Storage Temperature & Humidity	Temp: -10°C~40°C (14°F~104°F) Humidity: 65±20%RH
Flight Time	30 mins

Camera Gimbal Specifications

Operating Current	150mA@12V (Non-video Mode)
Input Voltage	12 V
Operating Temperature	-10°C~50°C(14°F~122°F)
Weight	67.5g (Camera incl.)
Dimensions (Damping Device excl.)	42m x 49mm x 45mm
Control Accuracy	Pitch: ±0.015° Roll: ±0.015° Yaw: ±0.015°
Max. Angular Velocity	Pitch: ±200°/S Yaw: ±200°/S
Controllable Range	Pitch: 0°~90° Yaw: ±50°

Camera Specifications

Operating Environment Temperature	0°C~40°C (32°F~104°F)
Still Photography Modes	Single shot Burst shooting Auto Exposure Bracketing (AEB) Time-lapse
Video Recording Modes	Normal
Max. Field of View	94°
Supported SD Card Types	Micro-SD card
Lense Diameter	25mm
Camera Bit Rate	100M
Storage capacity	4GB-128GB
File Formats	FAT32/exFAT Photo: JPG/DNG Video: MOV/MP4

Remote Control Specifications

OLED Screen Nits	330
Max. Operating Time	3.8 hours
RF Receiver Operating Frequency	2.4GHz~2.4835GHz 902MHz~928MHz
Video Link Frequency	2.4GHz~2.4835GHz
	902MHz~928MHz
Operating Temperature	0°C~40°C (32°F~104°F)
Storage Temperature	1 year: -20°C~25°C(-4°F~77°F)
	3 months: -20°C~45°C(-4°F~113°F)
Max. Control and Video Transmission Distance	7km
Transmission Power (EIRP)	FCC: <=26 dBm CE: <=20 dBm
Operating Current/Voltage	2A @ 3.6V
Battery	6700mAH
Power Consumption	7.2W
Weight (battery included)	370g



WWW.AUTELROBOTICS.COM

© 2017-2018 Autel Robotics Co.,Ltd. All Rights Reserved